

# CARDBOARD BOX

## INDICATIONS

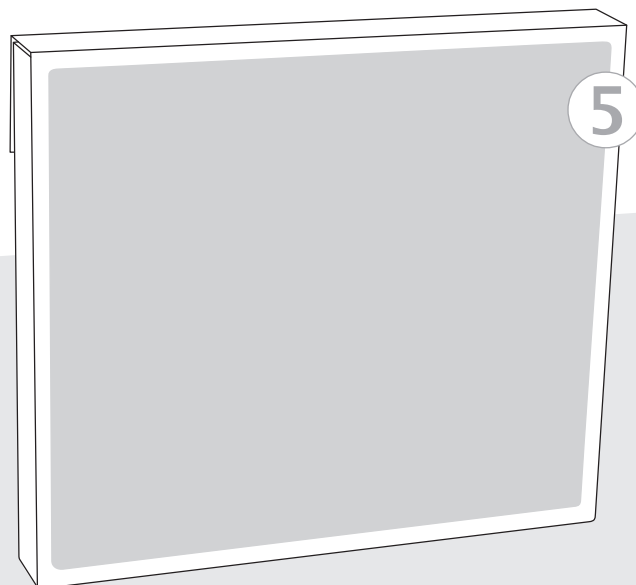

[www.qrcardboard.com](http://www.qrcardboard.com)

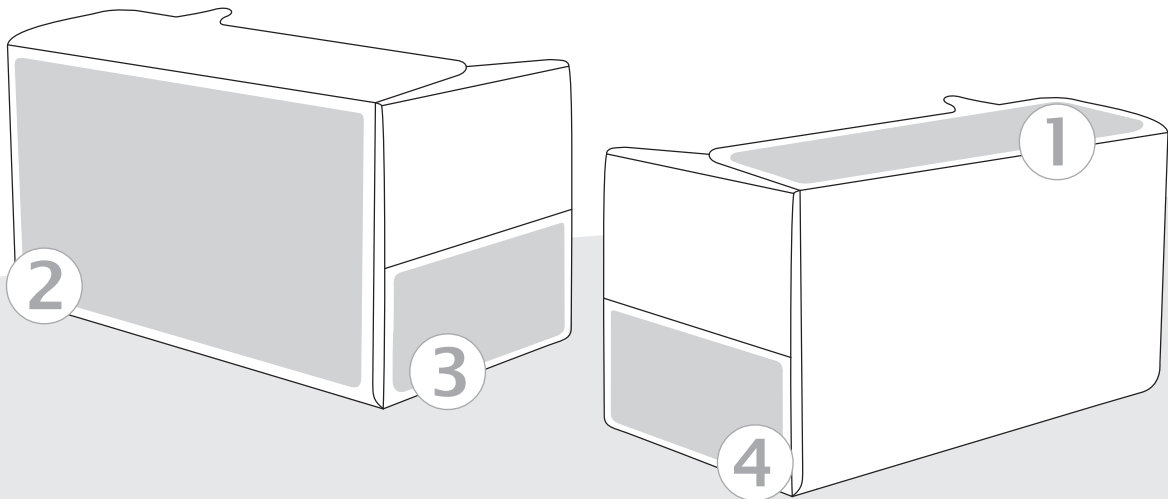

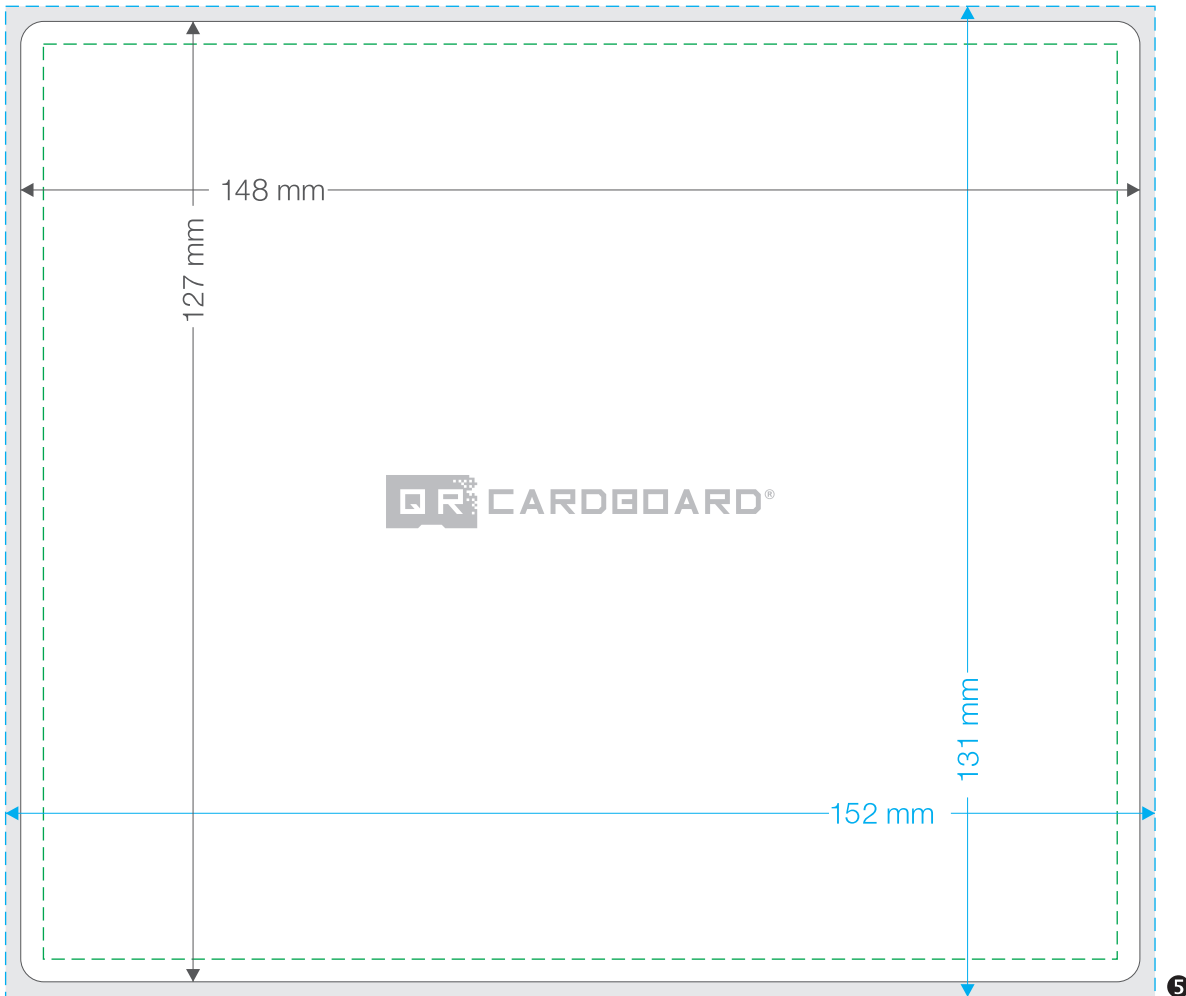
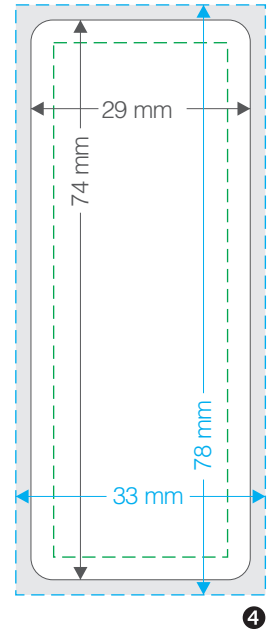
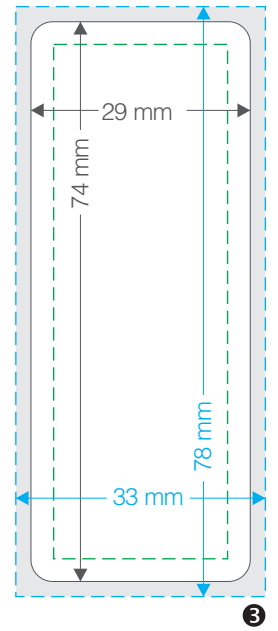
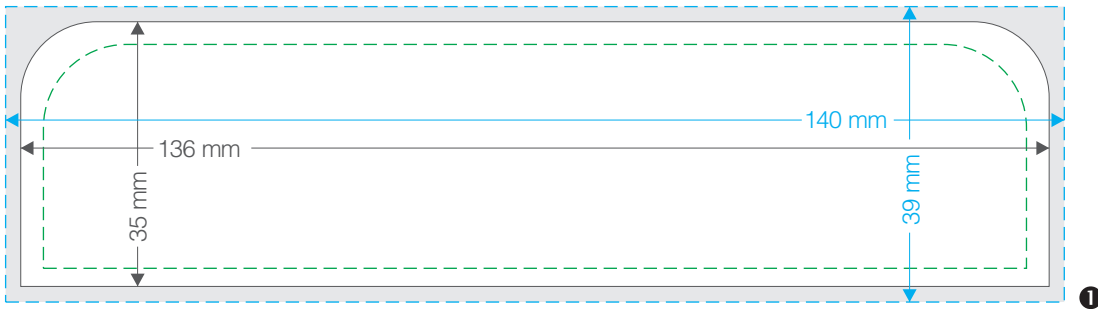

**L I O N**  
boutique hotel and spa

1

www.lion-hotelandspa.com

3



www.lion-hotelandspa.com

2



4



**L I O N**  
boutique hotel and spa

5



VIEWER PROFILE



VIEWER PROFILE



SAMPLE LAYOUT

## INDICATIONS

The following guidelines will help you create a correct print file.

Use the previous page as a base to place your graphics, in this way it will be easier to successfully create an executive file for printing. Eventually remove all bounding guidelines and logos contained in the guide layout areas except the bleeds (blue dotted line).

## LEGEND LAYOUT

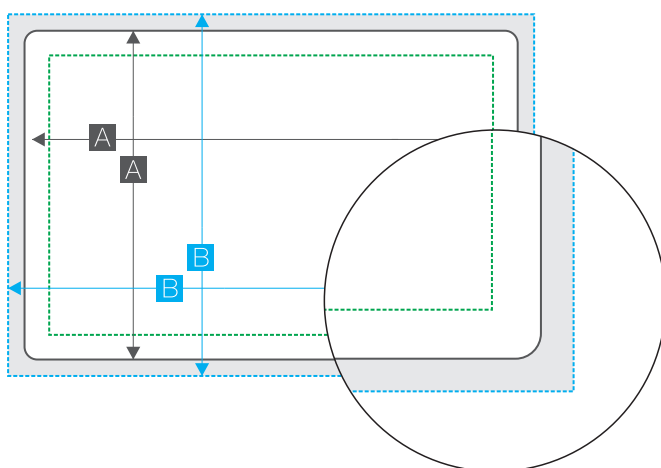

 **SAFETY AREA**  
**3 mm from the cutting**  
(for texts and important information)

 **Cutting line**  
(actual size of the adhesive)

 **PLENTY**  
**2 mm from the cut**  
(Extend backgrounds and images in these areas)

 **A**  
Final size  
of the sticker

 **B**  
Size of the adhesive  
including the crop margins

## RESOLUTION

300 dpi in scale 1: 1

## ACCEPTED FORMATS

JPG, TIFF, EPS, PSD, PDF, AI

## COLOURS

All files must be submitted in CMYK.

The images in RGB or Pantone colours will be converted to CMYK.

## FONT

The fonts must be embedded in PDF or converted to curves/dots.

## TECHNICAL FEATURES

- 34 mm lenses, 45 mm focal breadth for a clear and limpid viewing;
- Direct screen touch through ergonomic hole;
- Velcro closure for an optimal adherence;
- Cardboard support elastic band;
- Anti-sweating system;
- Pop-Up opening system;
- Safe elastic band for an efficient smartphone holding;
- Configuration QR CODE;
- Rigid, resistant and sustainable cardboard;

## INSTRUCTIONS

